



Asignatura	Inglés	Docente	Sandra Rodríguez	Jornada	T
Correo Docente	sandra.rodriguez@iedtecnicointernacional.edu.co			Curso	Segundo

Actividades

GUIDELINE 7

Goal: Aprender el vocabulario relacionado con los objetos y lugares de su escuela

Time: 2 Weeks

CLASSROOM OBJECTS

Activities

1. Draw , look and Match/ Colorea, traza, mira y relaciona





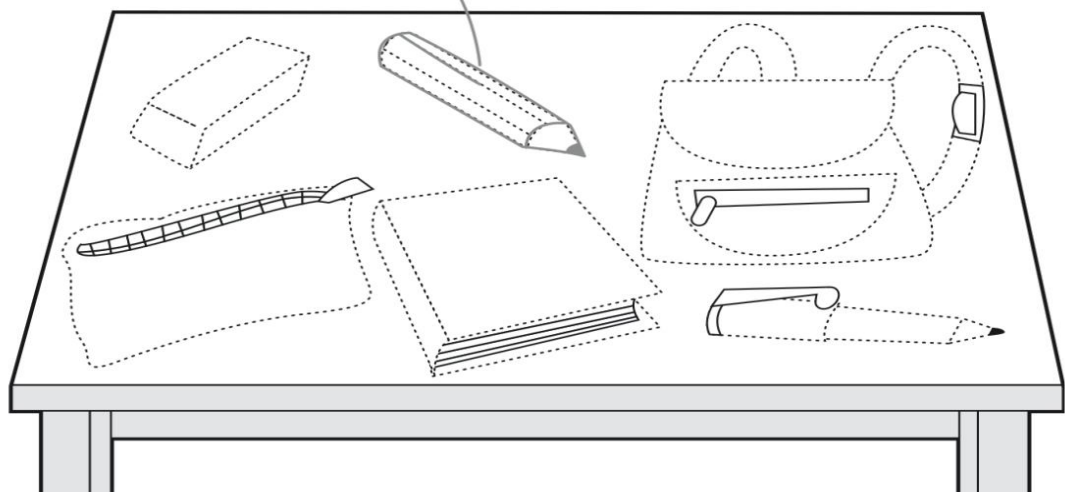

Reinforcement 1 Unit 1

➡ Draw. ➡ Look and match.

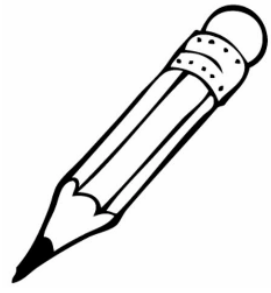

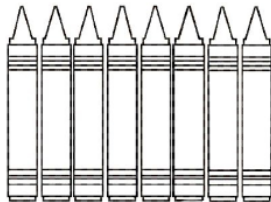

2. Colorea y escribe la palabra en el espacio correspondiente

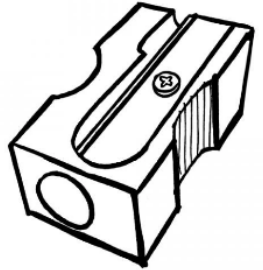
PEN			PENCIL
PEN			PENCIL
RULER			PENCIL CASE
RULER			PENCIL CASE
RUBBER			CRAYON
RUBBER			CRAYON
BAG			SHARPENER
BAG			SHARPENER